

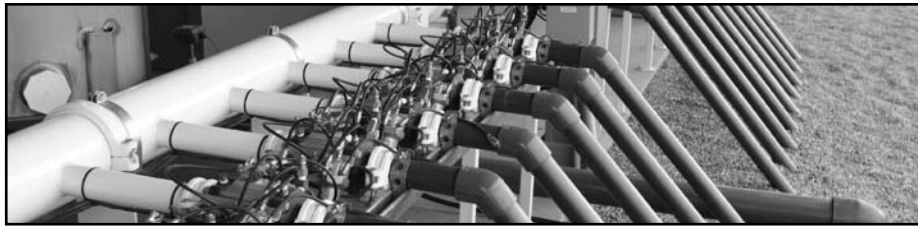

800 SERIES CONTROL VALVE ACCESSORIES GUIDE



CONTROL KITS FOR THE 800 SERIES CONTROL VALVE

MANUAL ON/OFF

The MANUAL ON/OFF control is used to fully open or close the valve.

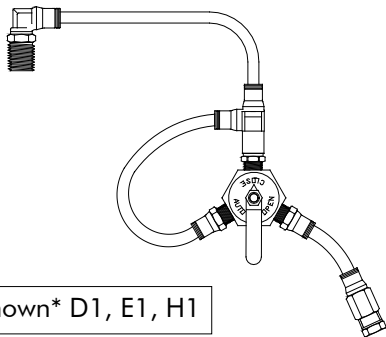

Option Shown* D1, E1, H1

ELECTRIC ON/OFF

The ELECTRIC ON/OFF is used to fully open or close the valve. When the selector is pointed to the "AUTO" position a electric solenoid is used to open or close the valve. The selector can also be used to manually open and close the valve.

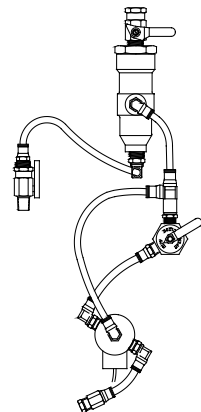

Option Shown* D1, E50, H2

PRESSURE REDUCING

The PRESSURE REDUCING control function will automatically reduce a higher inlet pressure to a constant lower downstream pressure. The pressure reducing control is adjustable to give a constant down stream pressure even with fluctuating upstream pressure. Also available with a solenoid.

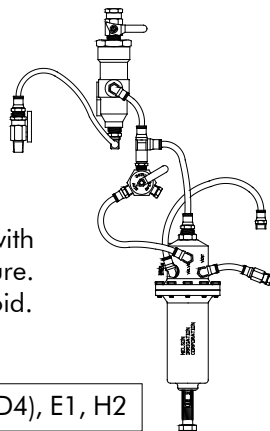

Option Shown* (D2, D3 or D4), E1, H2

PRESSURE SUSTAINING/RELIEF

The PRESSURE SUSTAINING/RELIEF control function will maintain a desired upstream pressure by allowing flow to pass downstream. This control is also used to protect pipe by relieving excess pressure. If ordering a solenoid in conjunction with this control contact the Nelson factory for information on function.

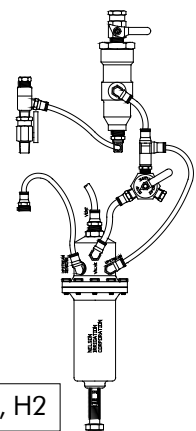

Option Shown* (D5, D8 or D9), E1, H2

*For a listing of all solenoids, filters and pressure ranges available with this control kit refer to page 3.

REMOTE MOUNTING KIT

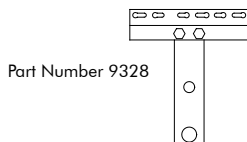

Part Number 9328

MOUNTING BRACKETS

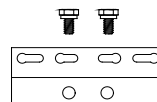

Valve Bracket
Part Number 9189

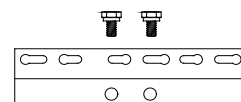

6 & 8 inch Valve Bracket
Part Number 8924

CONTROL KITS (cont'd)

PRESSURE SUSTAINING/REDUCING COMBO

The PRESSURE SUSTAINING/REDUCING COMBINATION control function maintains a constant upstream pressure against the pump during fill up. As downstream pressure rises to the desired downstream set point, pressure reducing control automatically takes over and maintains downstream set point.

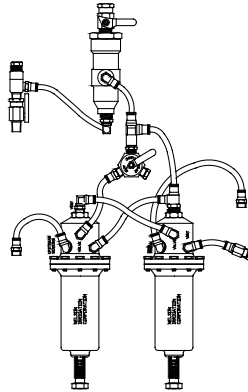

Option Shown* D4 & D5, E1, H2

RATE-OF-FLOW CONTROL

The RATE-OF-FLOW control function regulates the flow rate passing through the valve. The control can keep the valve from fully opening during startup. An adjustment screw can be set to give the desired flow rate.

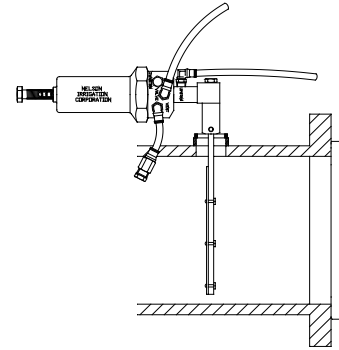

Option Shown* D18

PRESSURE REDUCING & ELECTRIC ON/OFF

The PRESSURE REDUCING control function is adjustable to give a constant downstream pressure even with fluctuating upstream pressure. A solenoid adds electric On/Off control. See page 3 for a list of all solenoid options.

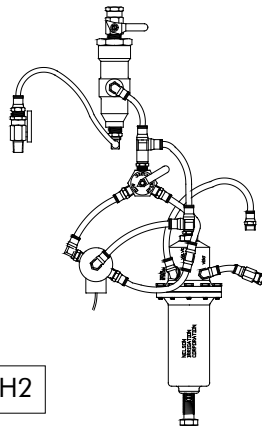

Option Shown* D3, E41, H2

HYDRAULIC REMOTE CONTROL

The HYDRAULIC REMOTE CONTROL fully opens or closes the valve. When the hydraulic relay receives a signal from a static line the valve opens. The valve is closed by removing pressure from the static line. Signal pressure must be equal to up-stream pressure. Can combine with Window+ controller for wire free control.

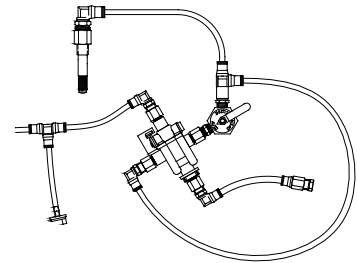

Option Shown* D1, E80, H3

SLEEVE EXHAUST

The Nelson 800 Series Valve is normally closed. The SLEEVE EXHAUST allows the control chamber water to drain out on shut down and the valve to open quickly when water arrives at the valve.

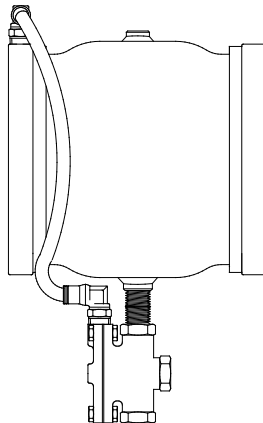

Option Shown* D6

SHUTTLE CHECK VALVE

The SHUTTLE CHECK VALVE feature will close the valve when the downstream pressure exceeds the inlet pressure to the valve upon system shutdown or solenoid actuation. Requires a solenoid or sustaining controller.

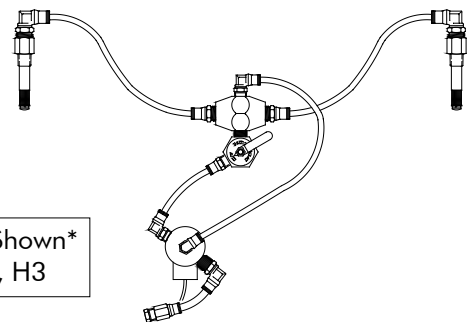

Option Shown* D7, E50, H3

*For a listing of all solenoids, filters and pressure ranges available with this control kit refer to page 3.

TO ORDER: Specify 800 Series Control Valve and Select From Each Letter Option, and a Pressure Gauge Option (See page 4). Any item in section D, E, & H can be ordered separately as a Kit. Specify the option letter and number (example "E50" for a 120 VAC 1/16" Solenoid Kit.).

A		B		C		D		E		H	
VALVE SIZE	VALVE CONNECTION STYLE	VALVE OPERATING PRESSURE	CONTROL FUNCTION (PSI in this column indicates range of adjustment.)		ON/OFF MODE		FILTER OPTIONS				
A2" ALUMINUM	B9 WAFER w/o bolts	C1 10-50 PSI C2 30-200 PSI C3 18-80 PSI	D1 MANUAL ON/OFF CTRL. D6 SLEEVE EXHAUST D7 SHUTTLE CHECK VALVE <small>(Must accompany solenoid or sustaining ctrl.)</small> D11 REDUCING 3 - 25 PSI D12 REDUCING 5 - 50 PSI D13 REDUCING 10 - 120 PSI D15 SUSTAINING 5 - 50 PSI D16 SUSTAINING 10 - 120 D18 RATE OF FLOW <small>(Specify In-Valve or Remote. Specify flow rate and pipe size.)</small>	E1 NO SOLENOID E20 12-24VDC 1/16" LATCHING <small>(.5 AMP MAX)</small> E21 12VDC 1/16" (.6 AMP MAX) E23 9/12VDC LATCHING <small>(Use with Window+ Valve Controllers.)</small> E34 24VDC 3/64" E43 24VAC (.13 AMP) E44 24VAC LDOS <small>(Long Distance Operating Solenoid)</small> E46 24VAC 1/16" (.43 AMP Inrush) E53 120VAC E60 220VAC 1/16"	H2 EXTERNAL H3* INTERNAL						
	B10 WAFER w/ bolts										
	B11 WAFER for Big Gun ANSI w/ bolts										
	B12 WAFER for Big Gun ANSI w/o bolts										
	B3 THREAD										
	B4 WAFER w/o bolts										
A2" CAST IRON A3" CAST IRON	B5 WAFER w/ bolts	C1 10-50 PSI C2 30-200 PSI C3 18-80 PSI	D1 MANUAL ON/OFF CTRL. D2 REDUCING 5 - 50 PSI D3 REDUCING 10 - 120 PSI D4 REDUCING 25 - 200 PSI D5 SUSTAINING 25 - 200 PSI D6 SLEEVE EXHAUST D7 SHUTTLE CHECK VALVE <small>(Must accompany solenoid or sustaining ctrl.)</small> D8 SUSTAINING 10 - 120 PSI D9 SUSTAINING 5 - 50 PSI D18 RATE OF FLOW <small>(Specify In-Valve or Remote. Specify flow rate and pipe size.)</small>	E1 NO SOLENOID E20 12-24VDC 1/16" LATCHING <small>(.5 AMP MAX)</small> E21 12VDC 1/16" (.6 AMP MAX) E23 9/12VDC LATCHING <small>(Use with Window+ Valve Controllers.)</small> E24 9/12VDC LATCHING <small>(Use with Window+ Valve Controllers.)</small> E30 24VDC 1/16" (.3 AMP MAX) E33 24VDC 3/64" LATCHING E40 24VAC 1/16" (.15 AMP Inrush) E41 24VAC 1/16" (1.1 AMP Inrush) <small>(Heavy Duty)</small> E42 24VAC 1/8" (3.6 AMP) E46 24VAC 1/16" (.43 AMP Inrush) E50 120VAC 1/16" <small>(Higher voltage solenoid kits available. Call for details.)</small> E52 120VAC 1/8" <small>(For 6" & 8" valve only.)</small> E80 Hydraulic Remote Ctrl.	H2 EXTERNAL H3 INTERNAL						
	B6 VICTAULIC										
	B7 WAFER for Big Gun ANSI w/ bolts										
	B8 WAFER for Big Gun ANSI w/o bolts										
	B4 WAFER w/o bolts										
	B5 WAFER w/ bolts										
A4" A6" A8"	B7 WAFER for Big Gun ANSI w/ bolts	C1 10-50 PSI C2 30-200 PSI C3 18-80 PSI	D1 MANUAL ON/OFF CTRL. D2 REDUCING 5 - 50 PSI D3 REDUCING 10 - 120 PSI D4 REDUCING 25 - 200 PSI D5 SUSTAINING 25 - 200 PSI D6 SLEEVE EXHAUST D7 SHUTTLE CHECK VALVE <small>(Must accompany solenoid or sustaining ctrl.)</small> D8 SUSTAINING 10 - 120 PSI D9 SUSTAINING 5 - 50 PSI D18 RATE OF FLOW <small>(Specify In-Valve or Remote. Specify flow rate and pipe size.)</small>	E1 NO SOLENOID E20 12-24VDC 1/16" LATCHING <small>(.5 AMP MAX)</small> E21 12VDC 1/16" (.6 AMP MAX) E23 9/12VDC LATCHING <small>(Use with Window+ Valve Controllers.)</small> E24 9/12VDC LATCHING <small>(Use with Window+ Valve Controllers.)</small> E30 24VDC 1/16" (.3 AMP MAX) E33 24VDC 3/64" LATCHING E40 24VAC 1/16" (.15 AMP Inrush) E41 24VAC 1/16" (1.1 AMP Inrush) <small>(Heavy Duty)</small> E42 24VAC 1/8" (3.6 AMP) E46 24VAC 1/16" (.43 AMP Inrush) E50 120VAC 1/16" <small>(Higher voltage solenoid kits available. Call for details.)</small> E52 120VAC 1/8" <small>(For 6" & 8" valve only.)</small> E80 Hydraulic Remote Ctrl.	H2 EXTERNAL H3 INTERNAL						
	B4 WAFER w/o bolts										
	B5 WAFER w/ bolts 4" Valve 6" Valve 8" Valve										

NOTE: See a current Nelson MNPPL price list for prices of all valve accessories and fittings.

ACCESSORIES FOR THE 800 SERIES CONTROL VALVE

INTERNAL FILTER

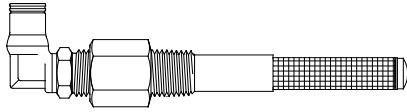

Option H3
Part Number 9805-001 (2" & 3" valves)
Part Number 9805-002 (4", 6" & 8" valves)

EXTERNAL FILTER

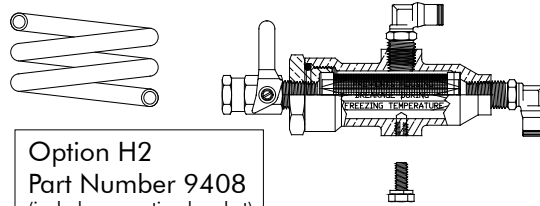

Option H2
Part Number 9408
(includes mounting bracket)

MANUAL SELECTOR VALVE

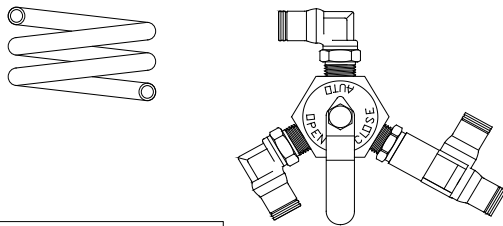

Part Number 8980

PRESSURE GAUGE QUICK CONNECT

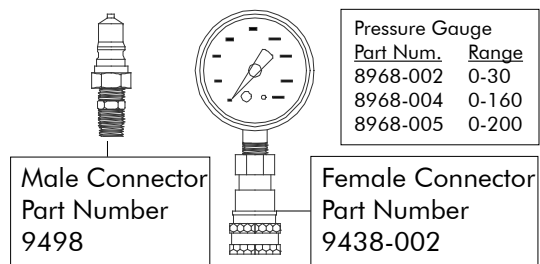

Part Num.	Range
8968-002	0-30
8968-004	0-160
8968-005	0-200

Male Connector
Part Number
9498

Female Connector
Part Number
9438-002

PRESSURE CONTROL

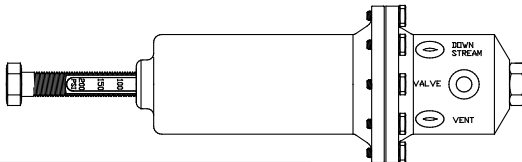

Regulation Range	Part Number
5 to 50 PSI	9366-001
10 to 120 PSI	9366-002
10 to 200 PSI	9366-003
Small Control for 2", 3" Valves below	
5 to 50 PSI	9692-001
10 to 120 PSI	9692-002

NOTE: Use same control for both pressure reducing and pressure sustaining and pressure relieving/relief controls. For pressure sustaining/relief order a label (part #9519) as well. Details from the Nelson factory.

SENSITIVITY BUSHING

Replaceable Sensitivity Bushing Inserts

Most Sensitive

Color

RED

BLUE

BLACK

Least Sensitive

Maintains the most accurate downstream pressure
Good all-around use (standard option)
Dampens upstream and downstream oscillations

Small Pressure Control

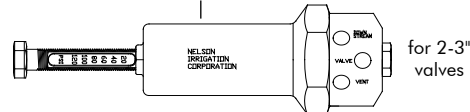

Large Pressure Control

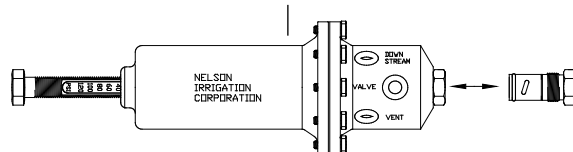

Color	For Large Pressure Control Part Number	For Small Pressure Control Part Number
RED	9554-012	9969-020
BLUE	9554-008	9969-010
BLACK	9554-003	N/A

Contact the Nelson factory for complete details and technical information on the sensitivity bushing.

BOLT KIT (2, 3 & 4 INCH)

Valve	Part Number	Bolts	Nuts	Washers
2"	9771	4	8	8
3"	9528	4	8	8
4"	9179	8	16	16

BOLT KIT (6 & 8 INCH)

Valve	Part Number	Bolts	Nuts
6"	8976	8	16
8"	9524	8	16

NOTE: See a current Nelson MNPPL for prices of all valve accessories and fittings.

FITTINGS

■ 5/32" used for 1998 and earlier. Thereafter 1/4" fittings are used for 2", 3", 4", 6" valves. 3/8" fittings are used on 8" valves.

Straight Tube Connector

SIZE	PART NUMBER
5/32 Tube x 1/8 MNPT	9526-001
5/32 Tube x 1/4 MNPT	9526-008
1/4 Tube x 1/8 MNPT	8970-001
1/4 Tube x 1/4 MNPT	8970-008
3/8 Tube x 1/4 MNPT	9494-008

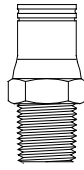

Straight Tube Connector

SIZE	PART NUMBER
5/32 Tube x 1/8 FNPT	9526-003
1/4 Tube x 1/8 FNPT	8970-003

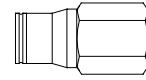

Elbow Tube Connector

SIZE	PART NUMBER
5/32 Tube x 1/8 MNPT	9526-002
5/32 Tube x 1/4 MNPT	9526-006
1/4 Tube x 1/8 MNPT	8970-002
1/4 Tube x 1/4 MNPT	8970-006
3/8 Tube x 1/4 MNPT	9494-006

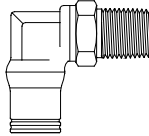

Union Tee

SIZE	PART NUMBER
5/32 Tube	9526-011
1/4 Tube	8970-011
3/8 Tube	9494-011

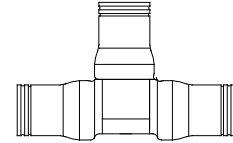

Tee Tube Connector

SIZE	PART NUMBER
5/32 Tube x 1/8 MNPT	9526-004
5/32 Tube x 1/4 MNPT	9526-007
1/4 Tube x 1/8 MNPT	8970-004
1/4 Tube x 1/4 MNPT	8970-007
3/8 Tube x 1/4 MNPT	9494-007

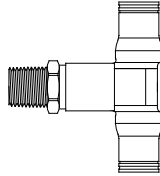

Nylon Tubing

SIZE	PART NUMBER	VALVE SIZE
5/32 O.D. Tube	9526-005	
1/4 O.D. Tube	8970-005	2" - 6"
3/8 O.D. Tube	9494-005	*8"

Black color Working Pressure 250 PSI



45° Street Elbow

1/4 MNPT X 1/4 FNPT
Part Number 9051

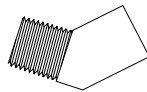

Male Run Tee

SIZE	PART NUMBER
5/32 Tube x 1/8 MNPT	9526-010
5/32 Tube x 1/4 MNPT	9526-009
1/4 Tube x 1/8 MNPT	8970-010
1/4 Tube x 1/4 MNPT	8970-009
3/8 Tube x 1/4 MNPT	9494-009

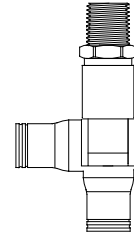

Isolation Valve

1/4 FNPT X 1/4 MNPT
Part Number 8972

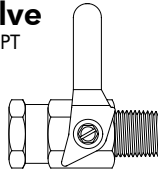

Needle Valve

1/8 FNPT X 1/8 FNPT
Part Number 9365

Used to control valve opening/closing speed.

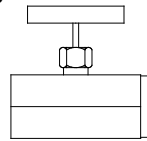

Street Tee

1/4 MNPT X 1/4 FNPT
Part Number 8971

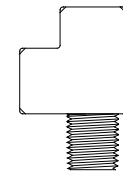

WINDOW+ BATTERY OPERATED CONTROLLER



Window+ Battery Operated Controller with Solenoid

Model/Part #	Description	For Use on Valve Size
E33-1	Window+ Controller with 12/24 VDC Latching Solenoid (1.2 mm orifice) Factory mounted on Valve or Kit w/ all required parts for install	2 and 3" Valves
11222-001	Window+ Controller and 12/24 VDC Latching Solenoid (1.2 mm orifice) Kit (not factory mounted)	2 and 3" Valves
E20-1	Window+ Controller with 12/24 VDC Latching Solenoid (1.6 mm orifice) Factory mounted on Valve or Kit w/ all required parts for install	4, 6, and 8" Valves
11222-002	Window+ Controller and 12/24 VDC Latching Solenoid (1.6 mm orifice) Kit (not factory mounted)	4, 6, and 8" Valves

SOLENOIDS

Ordering Instructions:

SOLENOID VALVE KITS

- When ordering a solenoid Valve "Kit" Specify a code number (example E21). Solenoid valve kits include bolts, tubing, a restrictor assembly, and an assortment of the fittings shown on the right. Specify the size of valve the kit is intended for to insure the correct sized tubing and fittings are sent. Mounting brackets are NOT included in the kits. See page 3 to order mounting brackets.

REPLACEMENT SOLENOIDS & COILS

- To order a replacement solenoid or coil use the part numbers listed below.

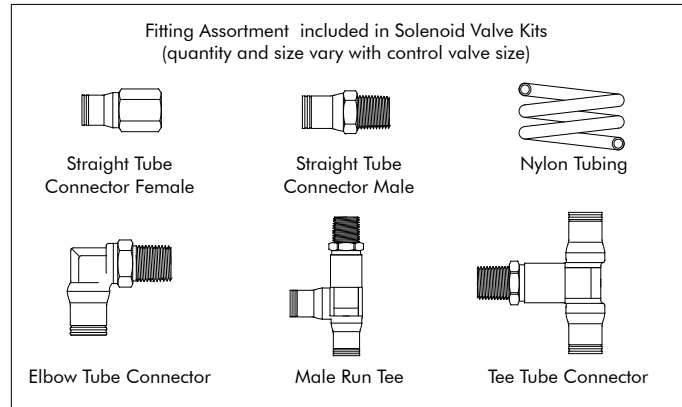

Voltage	Kit Code#	Old Kit Code#	Solenoid Only Part#	Coil Only Part#	Description
12-24VDC	E20-1	E2,F1	7510-040	7510-040	Latching, .5 AMP Max. 1/16" Orifice used in conjunction with battery operated controller. For two wire contact factory.
12VDC	E21	NA	7510-001	7510-101	.6 AMP holding. 1/16" Orifice. Three way normally open.
9/12VDC Latching	E23	NA	7510-052	7510-152	Low power (9V DC), 3/64" Orifice. Used in conjunction with battery operated controller on 2-3" valves.
	E24	NA	7510-072	7510-152	Low power (9V DC), 1/16" internal passages. Used in conjunction with battery operated controller on 4-8" valves for large internal passage size.
24VDC	E30	E3,F1	7510-002	7510-102	.3 AMP holding. 1/16" Orifice. Three-way normally open.
	E33	NA	7510-053	7510-153	Latching, 3/64" Orifice. Three-way solenoid for Window+ Controller.
24VAC	E40	E4,F1	7510-015	7510-115	.15 AMP inrush. 1/16" Orifice. Normally Open, Low power solenoid allows longer wire runs. Typical #12 wire run 3,500 foot (1,067 m).
	E41	E4.1, F1	7510-003	7510-103	1.1 AMP Inrush. 1/16" Orifice. Strong acting, High power to overcome seal drag and grit in the valve. Shorter wire runs typical #12 wire 1000 Feet (305 m).
	E42	E4,F2	7510-032	7510-132	3.6 AMP inrush. 1/8" Orifice. High Power; Strong Acting; Faster Opening & Closing Response Time. Recommend for the 6" and 8" Valves Only.
	E43	NA	7510-050	7510-150	.13 AMP Inrush. 3/64" Orifice. Low power — allows longer wire runs. Recommended for the 2" and 3" Valves only. Typical #12 wire run 3,500 Feet (1,067 m).
	E44	NA	7510-080	NA	.015 AMP Holding. 1/16" Orifice. Long Distance Operating Solenoid can be activated by a controller up to 3 miles from solenoid.
	E45	NA	7510-070	7510-150	1/16" internal passages. Solenoid actuated Hydraulic Relay.
120VAC	E46	NA	7510-016	7510-116	0.43 AMP Inrush. 1/16" Orifice.
	E50	E5,F1	7510-004	7510-104	.2 AMP Inrush. 1/16" Orifice.
	E52	E5,F2	7510-033	7510-133	.7 AMP Inrush. 1/8" Orifice. Faster opening & closing response time if a pressure control is present. Recommended for the 6" and 8" valves only.
220VAC	E53	NA	7510-051	7510-151	3/64" Orifice. Recommended for the 2" and 3" valves only.
	E60	E6,F1	7510-005	7510-105	.1 AMP Inrush. 1/16" Orifice.
440VAC	E62	E6,F2	7510-034	7510-134	.3 AMP Inrush. 1/8" Orifice. Faster opening & closing response time if a pressure control is present. Recommended for the 6" and 8" valves only.
	E70	E7,F1	7510-006	7510-106	.05 AMP Inrush. 1/16" Orifice.
440VAC	E72	E7,F2	7510-035	7510-135	.2 AMP Inrush. 1/8" Orifice. Faster opening & closing response time if a pressure control is present. Recommended for the 6" and 8" valves only.

NOTE: See a current Nelson MNPPL for prices of all valve accessories and fittings.

WARRANTY and DISCLAIMER: Nelson 800 Series Valve, Control Kits and Accessories are warranted for one year from date of original sale to be free of defective materials and workmanship when used within the working specifications for which the product was designed and under normal use and service. The manufacturer assumes no responsibility for installation, removal or unauthorized repair. The manufacturer's liability under this warranty is limited solely to replacement or repair of defective parts, and the manufacturer will not be liable for any crop or other consequential damages resulting from any defects in design or breach of warranty. THIS WARRANTY IS EXPRESSLY IN LIEU OF ALL OTHER WARRANTIES, EXPRESS OR IMPLIED, INCLUDING THE WARRANTIES OF MERCHANTABILITY AND FITNESS FOR PARTICULAR PURPOSES AND OF ALL OTHER OBLIGATIONS OR LIABILITIES OF MANUFACTURER. No agent, employee or representative of the manufacturer has authority to waive, alter or add to the provisions of warranty, nor to make representations or warranty not contained herein.